

Rysunek nr. 1

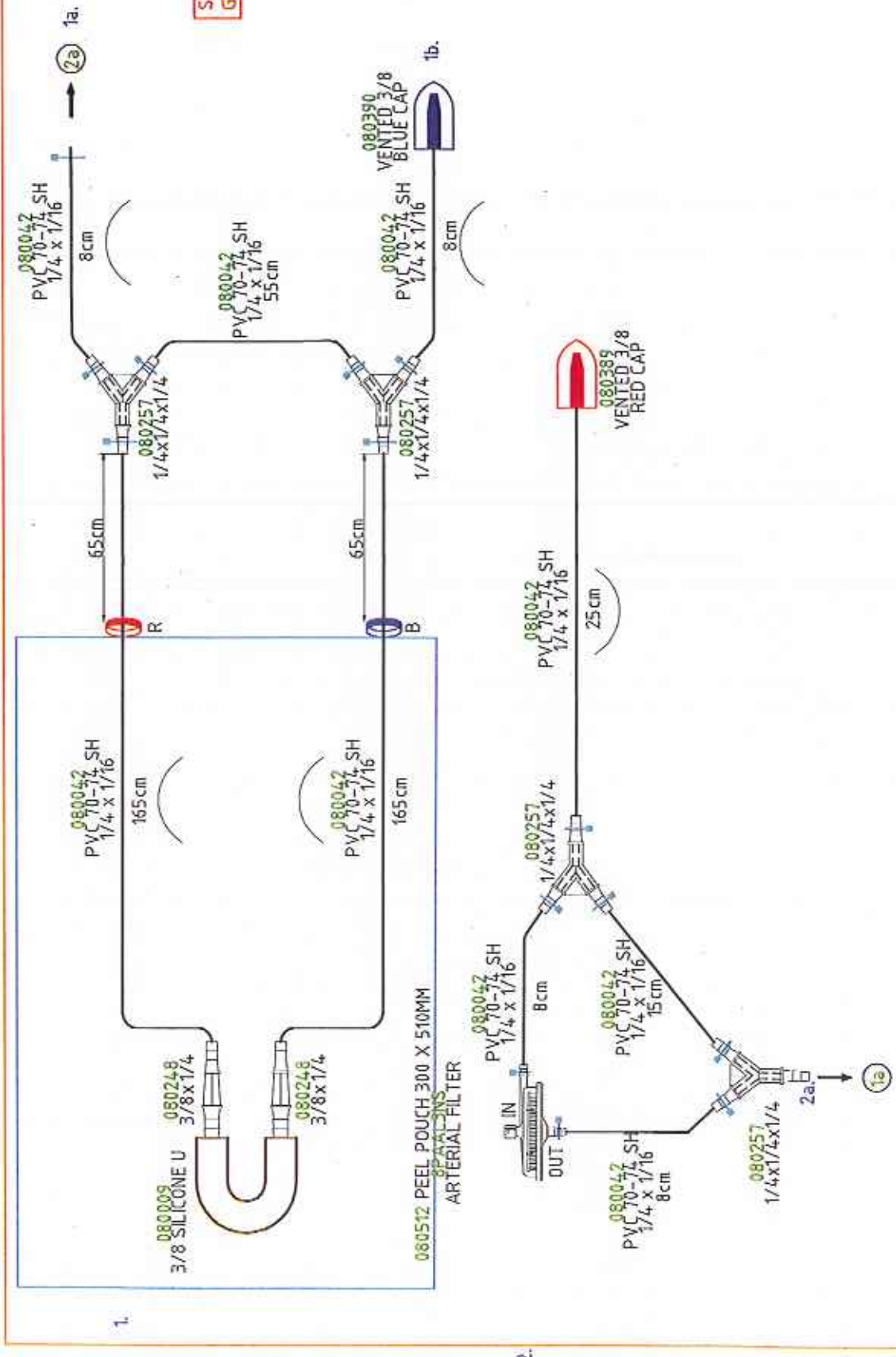

SECURE CLOSED WITH GREEN TWISTY TIE



<p>CUSTOMER: POZNAN POLAND</p>	<p>DESCRIPTION: INFANT PACK</p>	<p>ISSUED: 15/06/2012 AMENDED:</p>	<p>ISSUE No: 1 SHEET No: 1/4</p>
<p>PRODUCT CODE: 0012-116 CX-PL032</p>	<p>QUOTATION CODE: 0012-116 SPECIFICATION No:</p>	<p>THIS DOCUMENT IS THE PROPERTY OF TERUMO EUROPE AND MAY NOT BE COPIED BY ANY THIRD PARTY.</p>	

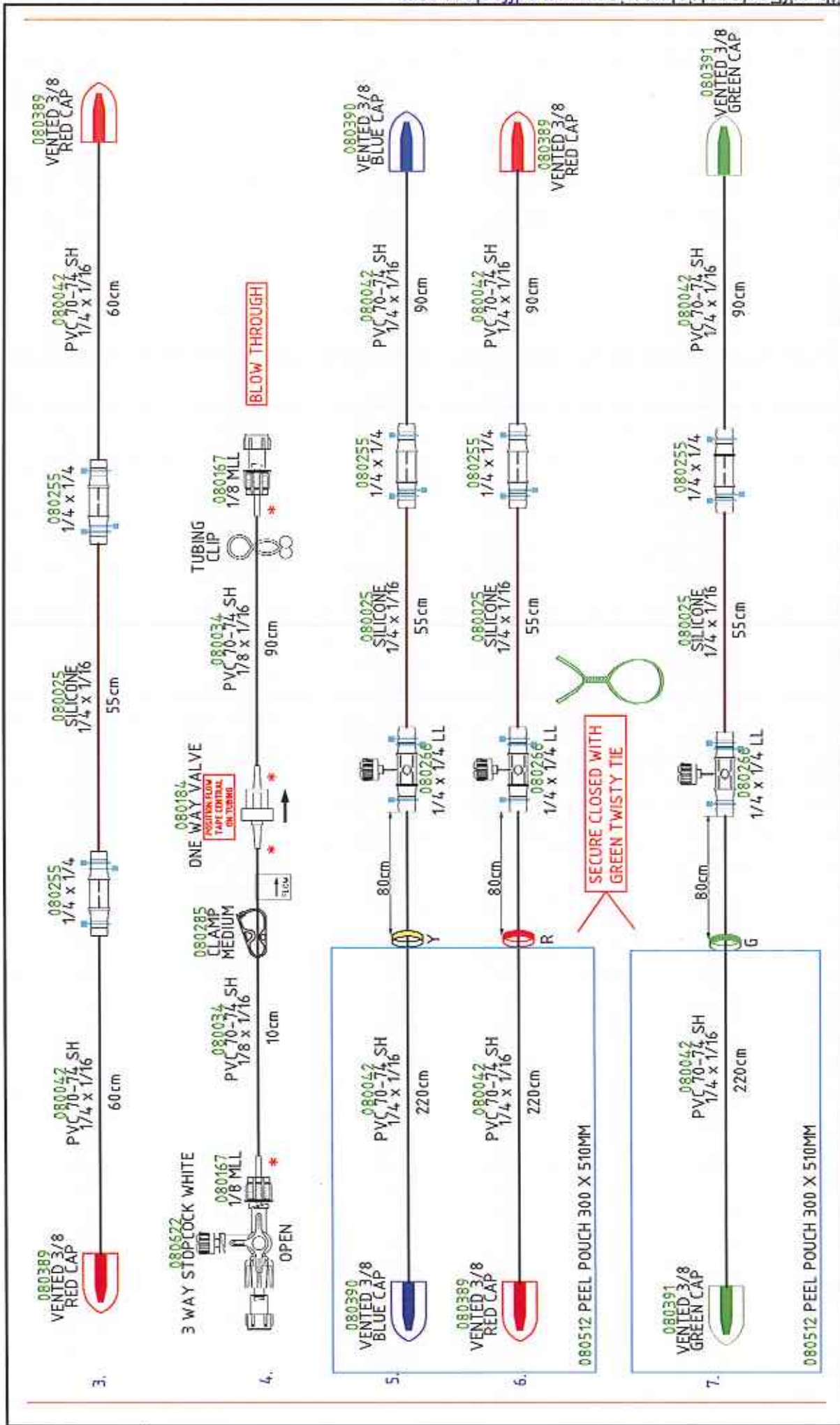

<p>CUSTOMER: POZNAN</p>	<p>DRAWN BY: LEE CHURCHILL INT. AMEND:</p>	<p>DESCRIPTION: INFANT PACK</p>
<p>ISSUE No: 1 SHEET No: 4/4</p>	<p>ISSUED: 15/06/2012 AMENDED:</p>	<p>QUOTATION CODE: 0012-116 SPECIFICATION No:</p>
<p>THIS DOCUMENT IS THE PROPERTY OF TERUMO EUROPE AND MAY NOT BE COPIED BY ANY THIRD PARTY.</p> <p>TERUMO We keep life flowing</p>		

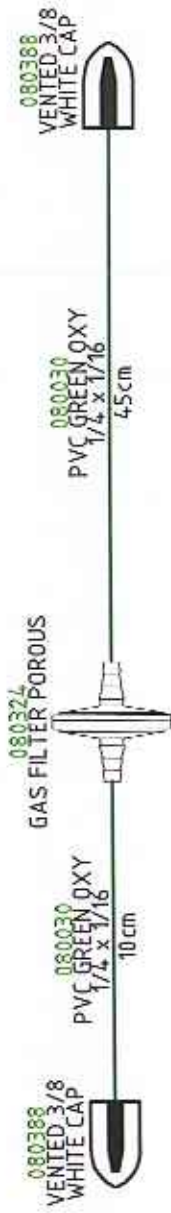

8.

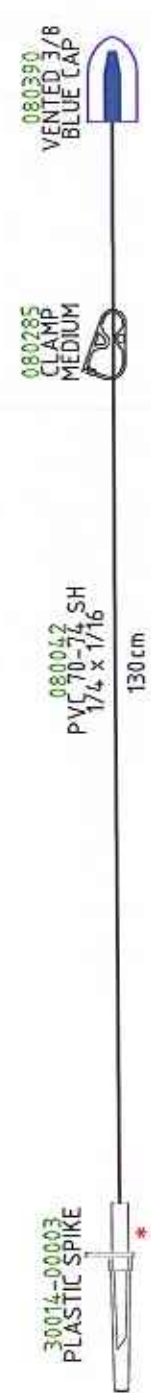

9.

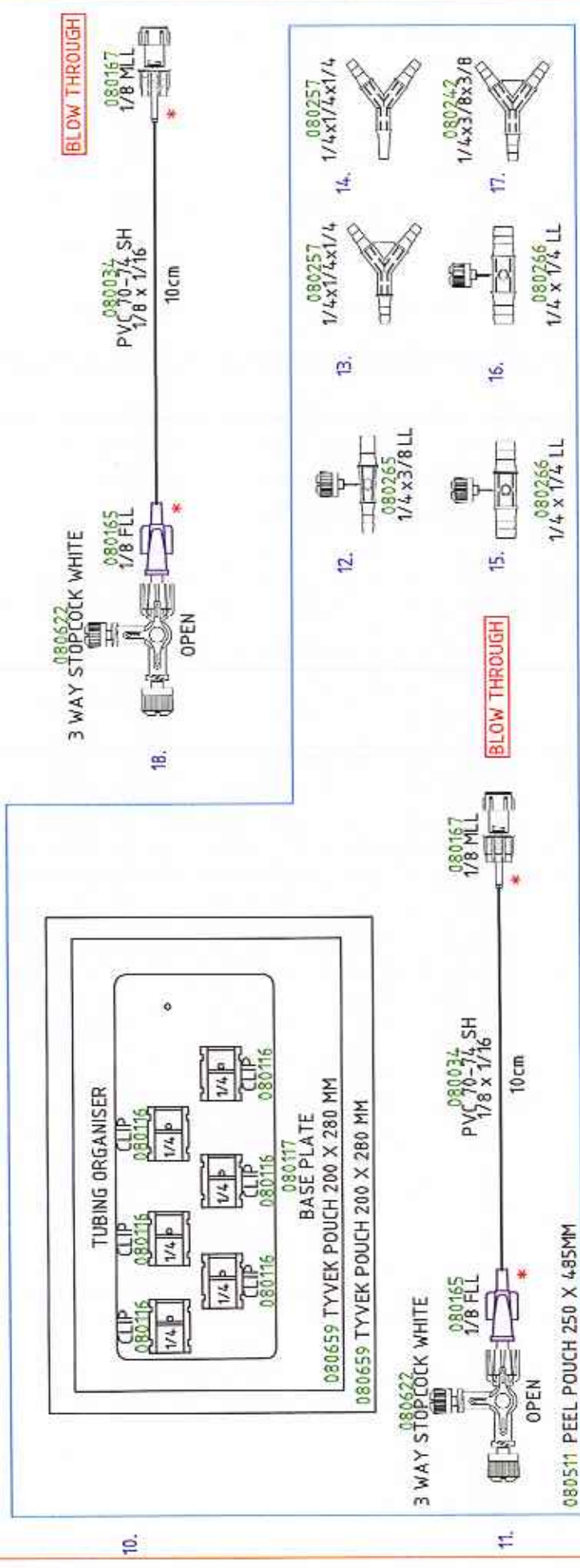

10.

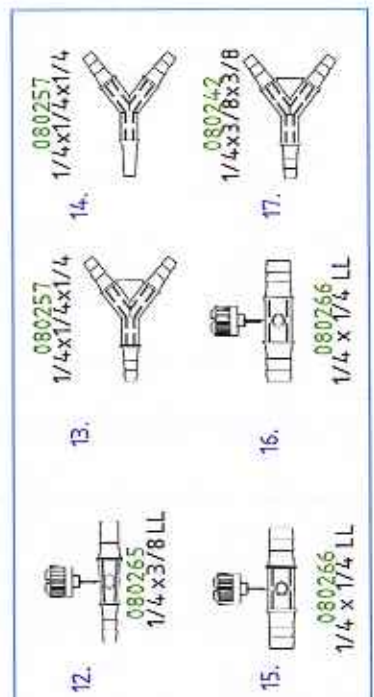

11.

080483 GAS POUCH 508 X 648 X 165 MM

CUSTOMER: POZNAN
DESCRIPTION: INFANT PACK
QUOTATION CODE: 0012-16
SPECIFICATION No:

DRAWN BY: LEE CHURCHILL
ISSUED: 15/06/2012
INT. AMEND:

ISSUE No: 1
SHEET No: 4/4



*THIS DOCUMENT IS THE PROPERTY OF TERUMO EUROPE AND MAY NOT BE COPIED BY ANY THIRD PARTY

LAYER PAD
080452
1

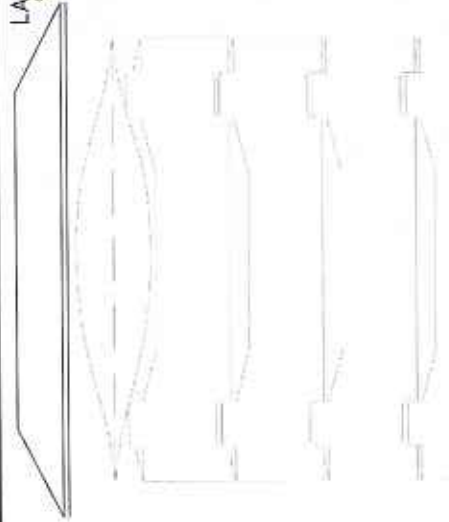

CARDBOARD TRAY
080504

CARD BOARD BOX
0.2
080503



375 x 310 x 575

PACKING INFORMATION

EACH GAS POUCH IS TO BE PACKED IN A CARDBOARD TRAY, ONE ON TOP OF ANOTHER. 5 PACKS PER BOX

PACKING ORDER TO BE CONFIRMED ON FIRST PRODUCTION AND IMAGES TAKEN.



PACK LABEL EXAMPLE



BOX LABEL EXAMPLE



CUSTOMER:
POZNAN

POLAND

PRODUCT CODE:
CX-PL052

DESCRIPTION:
INFANT PACK

QUOTATION CODE: SPECIFICATION No:
0017-116

DRAWN BY: LEE CHURCHILL
INT. AMEND:

ISSUED: 15/06/2012
AMENDED:

ISSUE No: 1
SHEET No: 4/4

THIS DOCUMENT IS THE PROPERTY OF TERUMO EUROPE AND MAY NOT BE COPIED BY ANY THIRD PARTY.

